



DESIGNLIGHT

SCANDINAVIAN AB

Art nr.:DB-762
E-nr: 7764295



Watt	Material	Kelvin	Armaturfärg	Effekt	Lumen(lm)
Watt	Material	Kelvin	Armature color	Effect	Lumen(lm)
230W	Aluminum	4000K	Black	129lm/W	28062LM

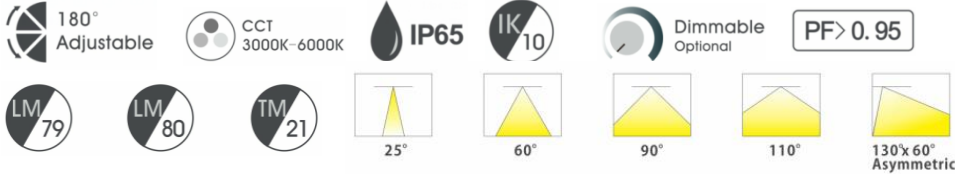

- 129lm/w med lens, driver
- 180lm/w utan lens, driver
- CRI Värdet > 70

- 129lm/w with lens and driver
- 180lm/w without lens and driver
- CRI>70

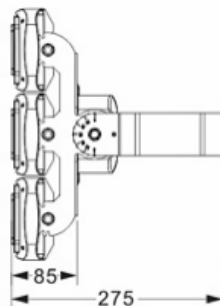
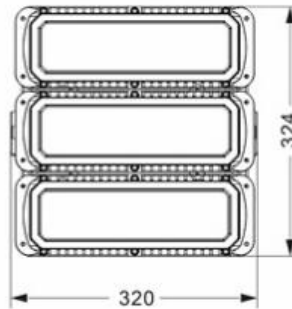
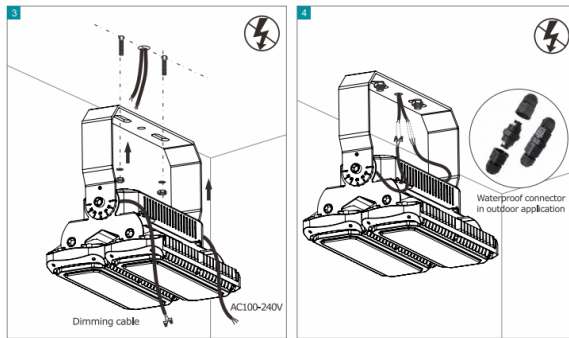
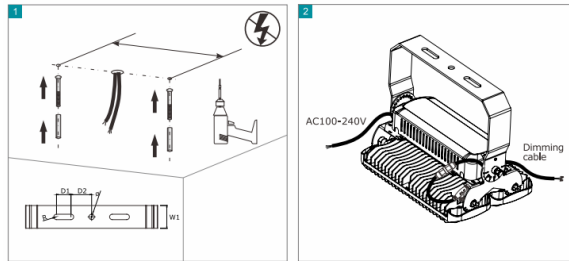
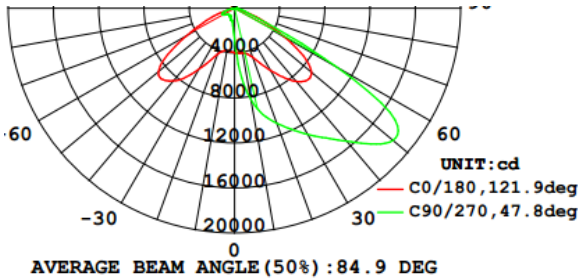

Flux out: 2363 lm

Height	Eavg, Emax	Angle: 45.46deg	Diameter
6.562ft 2m	96.96, 209.5fc 1044, 2255lx		5.498ft 167.58cm
13.12ft 4m	24.24, 52.38fc 260.9, 563.8lx		11ft 335.16cm
19.69ft 6m	10.77, 23.28fc 116.0, 250.6lx		16.49ft 502.74cm
26.25ft 8m	6.060, 13.09fc 65.23, 141.0lx		21.99ft 670.33cm
32.81ft 10m	3.879, 8.381fc 41.75, 90.21lx		27.49ft 837.91cm

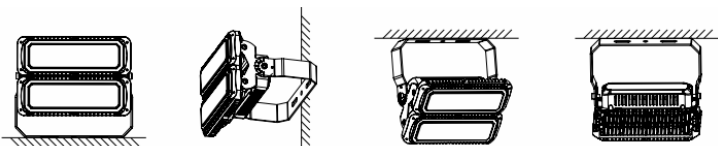

This luminaire contains built-in LED lamps.

The lamps cannot be changed in the luminaire.

874/2012

Komi håg vid montering av LED-strålkastare

1. Installation och underhåll får endast utföras av behörig installatör.
2. Ljuskällan till denna armatur är inte utbytbar, när den förbrukats ska hela armaturen bytas ut.
3. Notera att förändringar i kabelinstallation kan påverka IP-klassning.
4. Se till att fästsruvar fixeras med fjäderbricka och dras åt ordentligt.
5. Jordledning måste vara väl ansluten.
6. Se till att strålkastaren är ansluten till korrekt ingångsspänning.
7. Använd inte kemikalier eller frätande rengöringsmedel för att rengöra armaturen.
8. Minsta avstånd från belysta objekt till armaturer ska vara minst 0,3 m.
9. Trasig lens måste bytas ut av certifierad tekniker.

Things to remember when installing LED Floodlights

1. Installation and maintenance must be performed by professionals only.
2. The light source of this luminaire is not replaceable; when the light source reaches its end of life the whole luminaire shall be replaced.
3. Note that changes in cable installation may affect IP rating.
4. Please make sure the hook was fixed with spring washer and tighten up.
5. Ground wire must be well connected.
6. Please make sure the lamp is working with correct input voltage.
7. Do not use chemicals or corrosive cleaner to clean the fixture.
8. The minimum distance from lighted objects to luminaires shall be kept at least 0.3m.
9. Broken Glass must be replaced by certified technician.